

VS 2-40-N8 1.5 Bellows Vacuum Cup / Suction Cup

Part No.: 0215854

Product Features:

- Suitable for level adjustment. Several short bellows in one lifting device can handle objects with height differences and varying shapes, for example embossed or corrugated plates.
- Only lightweight objects should be handled when the lifting force is parallel to the surface of the object, in order to achieve good precision and safe lifting movement.
- Sealing ring included.



Scan QR code
with the
**piPARTS
SHOP** App

AVAILABLE
NOW



Material

Nitrile-PVC (NPV)	
Color	Black
Hardness	60 °Shore A
Temperature	0 - 80 °C

Material resistance

Nitrile-PVC (NPV)	
Alcohol	++
Concentrated acids	+
Ethanol	N/A
Hydrolysis	++
Methanol	N/A
Oil	+++
Oxidation	++
Gasoline	+++
Wear resistance	+++
Weather and ozone	++

- +++ Recommended
- ++ Good, minor chemical attack
- + Limited, moderate chemical attack, limited service
- Not recommended

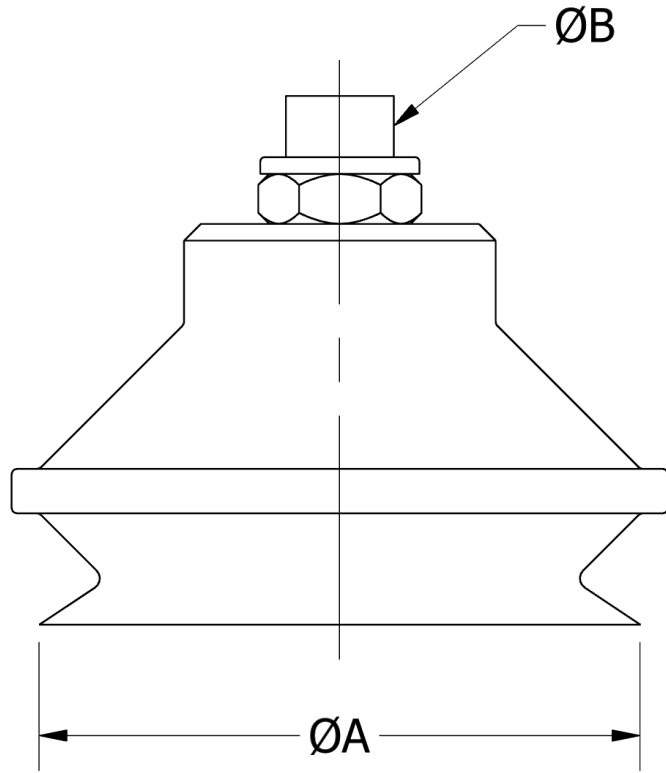

Nitril (N) Cup Material					
A	B	Weight (g)	Replacement Cup	Weight (g)	Adapter
40	G 1/8"	19	VN 2-40-N	14	VSA 50